

KOHLER AEGIS®

LH630, LH640, LH685, LH690, LH755, LH775

LIQUID-COOLED

HORIZONTAL CRANKSHAFT

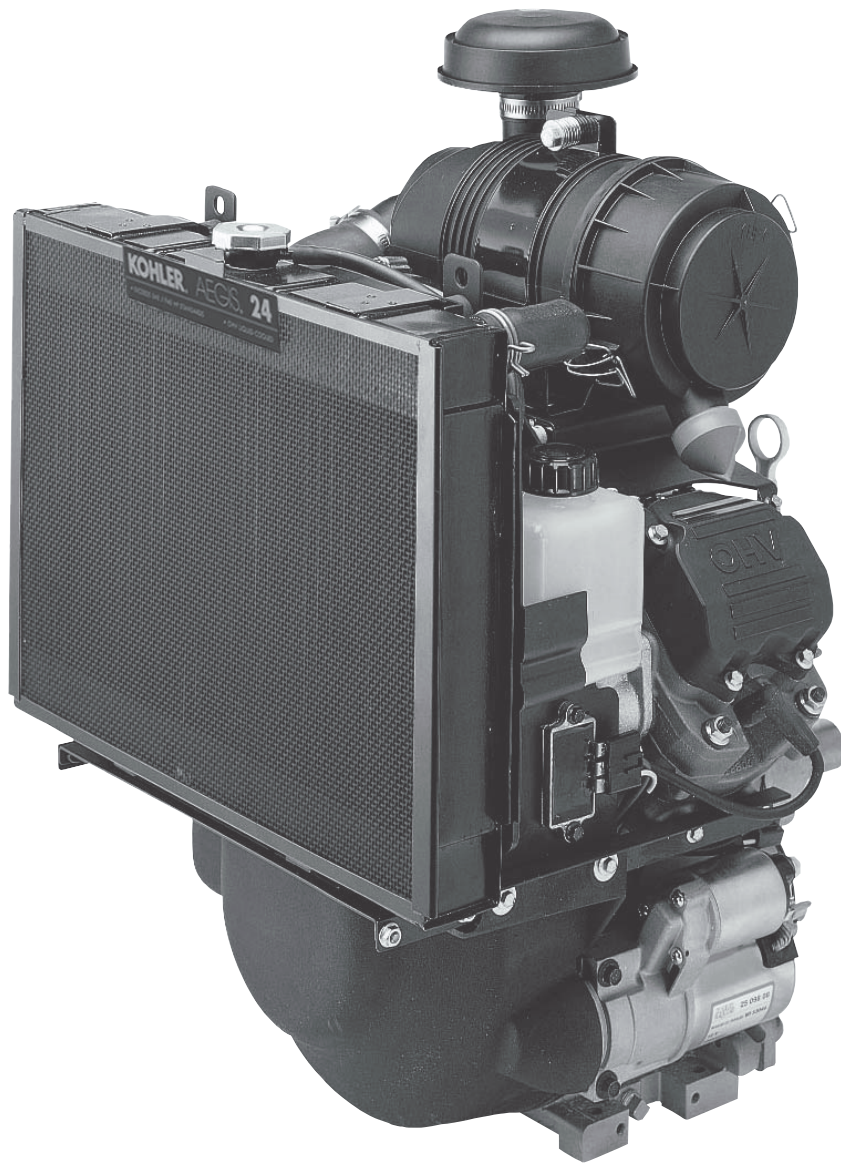

Safety Precautions

To ensure safe operations please read the following statements and understand their meaning. Also refer to your equipment owner's manual for other important safety information. This manual contains safety precautions which are explained below. Please read carefully.

WARNING

Warning is used to indicate the presence of a hazard that *can* cause *severe* personal injury, death, or substantial property damage if the warning is ignored.

CAUTION



Caution is used to indicate the presence of a hazard that *will* or *can* cause *minor* personal injury or property damage if the caution is ignored.

NOTE

Note is used to notify people of installation, operation, or maintenance information that is important but not hazard-related.



For Your Safety!

These precautions should be followed at all times. Failure to follow these precautions could result in injury to yourself and others.

 WARNING

Explosive Fuel can cause fires and severe burns. Do not fill the fuel tank while the engine is hot or running.

Explosive Fuel!



Gasoline is extremely flammable and its vapors can explode if ignited. Store gasoline only in approved containers, in well ventilated, unoccupied buildings, away from sparks or flames. Do not fill the fuel tank while the engine is hot or running, since spilled fuel could ignite if it comes in contact with hot parts or sparks from ignition. Do not start the engine near spilled fuel. Never use gasoline as a cleaning agent.

 WARNING

Hot liquid can cause severe burns. Do not loosen radiator cap while engine is operating or warm to the touch.

Hot Liquid!

The liquid coolant can get extremely hot from operation. Turning the radiator cap when the engine is hot can allow steam and scalding liquid to blow out and burn you severely.

Shut off machine. Only remove radiator cap when cool enough to touch with bare hands. Slowly loosen cap to first stop to relieve pressure before removing completely.

 WARNING

Hot Parts can cause severe burns. Do not touch engine while operating or just after stopping.

Hot Parts!

Engine components can get extremely hot from operation. To prevent severe burns, do not touch these areas while the engine is running, or immediately after it is turned off. Never operate the engine with heat shields or guards removed.

California Proposition 65 Warning
<i>Engine exhaust from this product contains chemicals known to the State of California to cause cancer, birth defects, or other reproductive harm.</i>



Safety Precautions (Cont.)

 WARNING

Accidental Starts can cause severe injury or death. Disconnect and ground spark plug leads before servicing.



Accidental Starts!

Disabling engine. Accidental starting can cause severe injury or death. Before working on the engine or equipment, disable the engine as follows: 1) Disconnect the spark plug lead(s). 2) Disconnect negative (-) battery cable from battery.

 WARNING

Carbon Monoxide can cause severe nausea, fainting or death. Avoid inhaling exhaust fumes, and never run the engine in a closed building or confined area.



Lethal Exhaust Gases!

Engine exhaust gases contain poisonous carbon monoxide. Carbon monoxide is odorless, colorless, and can cause death if inhaled. Avoid inhaling exhaust fumes, and never run the engine in a closed building or confined area.

 WARNING

Explosive Gas can cause fires and severe acid burns. Charge battery only in a well ventilated area. Keep sources of ignition away.



Explosive Gas!

Batteries produce explosive hydrogen gas while being charged. To prevent a fire or explosion, charge batteries only in well ventilated areas. Keep sparks, open flames, and other sources of ignition away from the battery at all times. Keep batteries out of the reach of children. Remove all jewelry when servicing batteries.

 CAUTION

Electrical Shock can cause injury. Do not touch wires while engine is running.

Electrical Shock!

Never touch electrical wires or components while the engine is running. They can be sources of electrical shock.

 WARNING

Rotating Parts can cause severe injury. Stay away while engine is in operation.

Rotating Parts!

Keep hands, feet, hair, and clothing away from all moving parts to prevent injury. Never operate the engine with covers, shrouds, or guards removed.

Before disconnecting the negative (-) ground cable, make sure all switches are OFF. If ON, a spark will occur at the ground cable terminal which could cause an explosion if hydrogen gas or gasoline vapors are present.

Congratulations – You have selected a fine four-cycle, twin cylinder, liquid-cooled engine. Kohler designs long life strength and on-the-job durability into each engine...making a Kohler engine dependable...dependability you can count on. Here are some reasons why:

- Efficient overhead valve design, and pressure lubrication provide maximum power, torque, and reliability under all operating conditions.
- Dependable, maintenance-free electronic ignition ensures fast, easy starts time after time.
- Kohler engines are easy to service. All routine service areas (like the dipstick and oil fill, air cleaner, spark plugs, and carburetor) are easily and quickly accessible.
- Parts subject to the most wear and tear (like the cylinder liner and camshaft) are made from precision formulated cast iron.
- Every Kohler engine is backed by a worldwide network of over 10,000 distributors and dealers. Service support is just a phone call away. Call 1-800-544-2444 (U.S. & Canada) for Sales & Service assistance.

To keep your engine in top operating condition, follow the maintenance procedures in this manual.

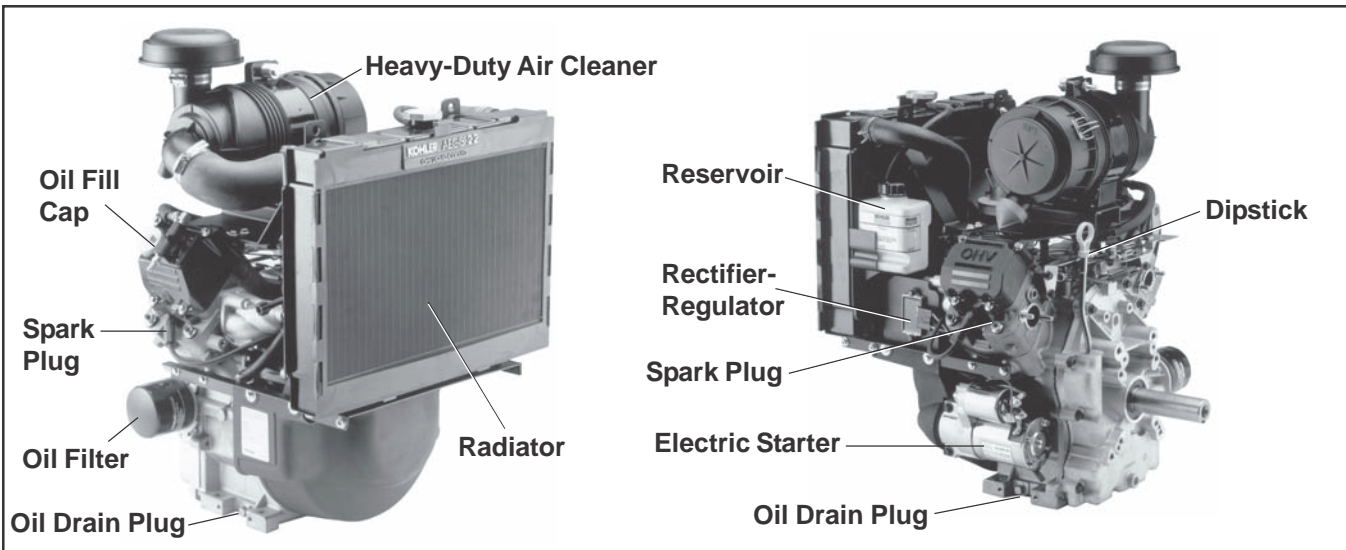

Figure 1. Typical Kohler Aegis® Carbureted Engine.

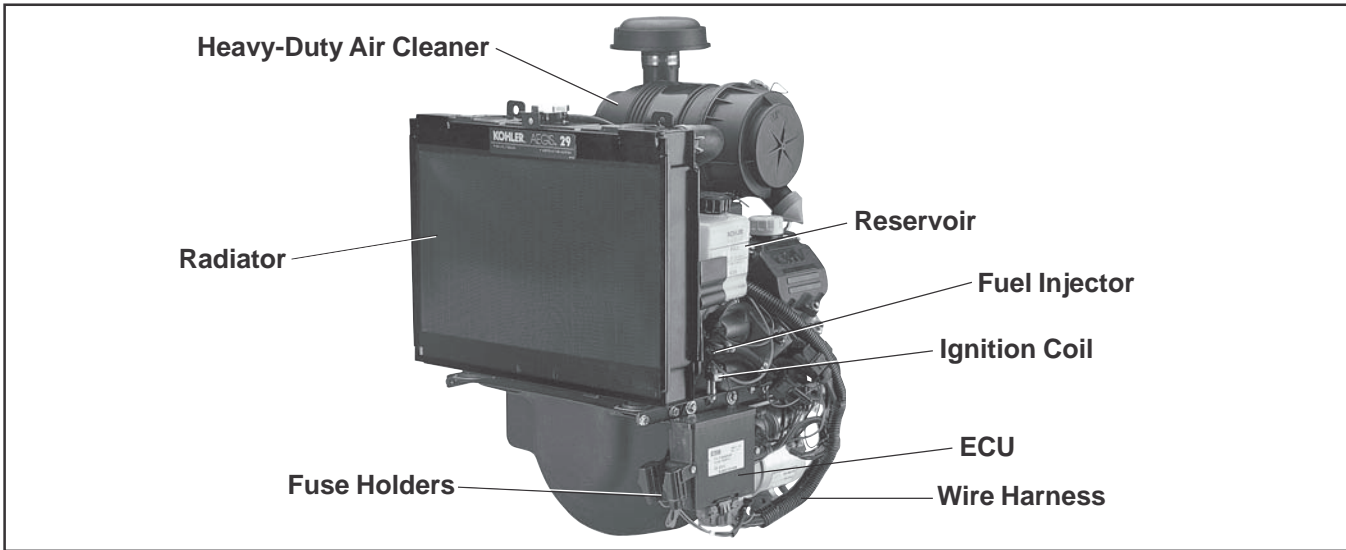

Figure 2. Typical Kohler Aegis® EFI Engine.

Oil Recommendations

Using the proper type and weight of oil in the crankcase is extremely important. So is checking oil daily and changing oil regularly. Failure to use the correct oil, or using dirty oil, causes premature engine wear and failure.

Oil Type

Use high quality detergent oil of API (American Petroleum Institute) service class SG, SH, SJ or higher. Synthetic oils may be used. Select the viscosity based on the air temperature at the time of operation as shown in the following table.

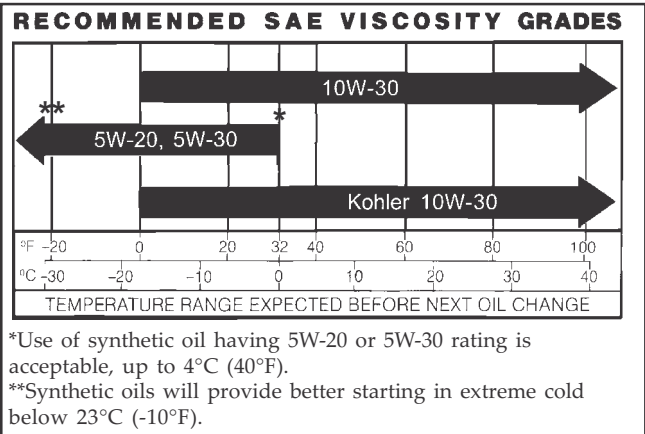

Figure 3. Viscosity Grades Table.

NOTE: Using other than service class SG, SH, SJ or higher oil or extending oil change intervals longer than recommended can cause engine damage.

NOTE: Synthetic oils meeting the listed classifications may be used with oil changes performed at the recommended intervals. However to allow piston rings to properly seat, a new or rebuilt engine should be operated for at least 50 hours using standard petroleum based oil before switching to synthetic oil.

A logo or symbol on oil containers identifies the API service class and SAE viscosity grade. See Figure 4.



Figure 4. Oil Container Logo.

Refer to Maintenance Instructions beginning on page 8 for detailed oil check, oil change, and oil filter change procedures.

Fuel Recommendations



WARNING: Explosive Fuel!

Gasoline is extremely flammable and its vapors can explode if ignited. Store gasoline only in approved containers, in well ventilated, unoccupied buildings, away from sparks or flames. Do not fill the fuel tank while the engine is hot or running, since spilled fuel could ignite if it comes in contact with hot parts or sparks from ignition. Do not start the engine near spilled fuel. Never use gasoline as a cleaning agent.

General Recommendations

Purchase gasoline in small quantities and store in clean, approved containers. A container with a capacity of 2 gallons or less with a pouring spout is recommended. Such a container is easier to handle and helps eliminate spillage during refueling.

Do not use gasoline left over from the previous season, to minimize gum deposits in your fuel system and to insure easy starting.

Do not add oil to the gasoline. Do not overfill the fuel tank. Leave room for the fuel to expand.

Fuel Type

For best results use only clean, fresh, **unleaded** gasoline with the pump sticker octane rating of 87 or higher. In countries using the Research method, it should be 90 octane minimum.

Unleaded gasoline is recommended as it leaves less combustion chamber deposits and reduces harmful exhaust emissions. Leaded gasoline is not recommended and **must not** be used on EFI engines, or on other models where exhaust emissions are regulated.

Gasoline/Alcohol blends

Gasohol (up to 10% ethyl alcohol, 90% unleaded gasoline by volume) is approved as a fuel for Kohler engines. Other gasoline/alcohol blends including E20 and E85 are not to be used and not approved. Any failures resulting from use of these fuels will not be warranted.

Gasoline/Ether blends

Methyl Tertiary Butyl Ether (MTBE) and unleaded gasoline blends (up to a maximum of 15% MTBE by volume) are approved as a fuel for Kohler engines. Other gasoline/ether blends are not approved.

Coolant Recommendations

Use equal parts of ethylene glycol (anti-freeze) and water only. Distilled or deionized water is recommended, especially in areas where the water contains a high mineral content. Propylene glycol based anti-freeze is **not** recommended.

This mixture will provide protection from -37°C (-34°F) to 108°C (226°F). For protection and use outside the indicated temperature limits, follow the anti-freeze manufacturers instructions on the container, but do not exceed 70% anti-freeze.

DO NOT use anti-freeze with stop-leak additive(s), or put any other additives in the cooling system.

Engine Identification Numbers

When ordering parts, or in any communication involving an engine, always give the **Model, Specification, and Serial Numbers** of the engine.

The engine identification numbers appear on a decal, affixed to the engine. The primary location is on the side of the flywheel cover. Placement may vary due to OEM requirements and specific options involved.

Record your engine identification numbers on the identification label (Figure 5) for future reference.

For Models LH630, LH640, LH685, LH690

KOHLER[®]

IMPORTANT ENGINE INFORMATION
 THIS ENGINE MEETS U.S. EPAPH2, EC STAGE II (SN:4) AND CA 2008 AND LATER EXH EMISSION REGS FOR SI SORE

FAMILY
TYPE APP
DISPL. (CC)
MODEL NO.
SPEC. NO.
SERIAL NO.
BUILD DATE
OEM PROD. NO.

EMISSION COMPLIANCE PERIOD:
 EPA: CARB:
 CERTIFIED ON:
 REFER TO OWNER'S MANUAL FOR HP RATING, SAFETY, MAINTENANCE AND ADJUSTMENTS

1-800-544-2444 www.kohlerengines.com
 KOHLER CO. KOHLER, WISCONSIN USA

For Models LH755 and LH775

KOHLER[®]

IMPORTANT ENGINE INFORMATION
 THIS ENGINE MEETS EMISSION REGS FOR U.S. EPA 2005 AND LATER AND EC STAGE II (SN:4) SI SMALL OFF-ROAD ENGINES AND CA 2005 AND LATER LSI ENGINES

FAMILY
TYPE APP
DISPL. (CC)
MODEL NO.
SPEC. NO.
SERIAL NO.
BUILD DATE
OEM PROD. NO.

EMISSION COMPLIANCE PERIOD:
 EPA: CARB:
 CERTIFIED ON:
 REFER TO OWNER'S MANUAL FOR HP RATING, SAFETY, MAINTENANCE AND ADJUSTMENTS

1-800-544-2444 www.kohlerengines.com
 KOHLER CO. KOHLER, WISCONSIN USA

Figure 5. Engine Identification Label.

The Emission Compliance Period referred to on the Emission Control or Air Index label indicates the number of operating hours for which the engine has been shown to meet Federal and CARB emission requirements. The following table provides the Engine Compliance Period (in hours) associated with the category descriptor found on the certification label.

Emission Compliance Period (Hours)

EPA	Category C 250 Hours	Category B 500 Hours	Category A 1000 Hours
CARB	Moderate 125 Hours	Intermediate 250 Hours	Extended 500* Hours

*Extended hours for Models LH755 and LH775 is 1000.

Refer to certification label for engine displacement.

Exhaust Emission Control System for models LH630, LH640, LH685, LH690 and LH755 is EM. Exhaust Emission Control System for model LH775 is EM, O2S, ECM, MFI.

Model Designation

Model LH690 for example: L designates liquid cooled, H designates horizontal crankshaft, and 690 is the model designation. A letter suffix designates a specific version as follows:

Suffix	Designates
S	Electric Start

Operating Instructions

Also read the operating instructions of the equipment this engine powers.

Pre-Start Checklist

- Check oil level. Add oil if low. Do not overfill.
- Check coolant level. Add coolant if low.
- Check fuel level. Add fuel if low.
- Check radiator, cooling air intake areas and external surfaces of engine. Make sure they are clean and unobstructed.
- Check that the air cleaner components and all shrouds, equipment covers, and guards are in place and securely fastened.
- Check that any clutches or transmissions are disengaged or placed in neutral. This is especially important on equipment with hydrostatic drive. The shift lever must be exactly in neutral to prevent resistance which could keep the engine from starting.



WARNING: Lethal Exhaust Gases!

Engine exhaust gases contain poisonous carbon monoxide. Carbon monoxide is odorless, colorless, and can cause death if inhaled. Avoid inhaling exhaust fumes, and never run the engine in a closed building or confined area.

Cold Weather Starting Hints

1. The cooling system must be filled with coolant capable of providing proper protection against freezing at the lowest temperature expected (see Coolant Recommendations on page 5).
2. Be sure to use the proper oil for the temperature expected. See Figure 3 on page 4.
3. Declutch all possible external loads.

-
4. A warm battery has much more starting capacity than a cold battery.
 5. Use fresh winter grade fuel. NOTE: Winter grade gasoline has higher volatility to improve starting. Do not use gasoline left over from summer.

Starting

1. Place the throttle control **midway** between the **slow** and **fast** positions. Place the choke control (non-EFI engines only) into the **on** position.
2. Start the engine by activating the key switch. Release the switch as soon as the engine starts.

EFI Engines Only – Initial Starting or After Running out of Fuel (Dry System)

- a. Turn the key switch to the **on** position for one minute. Allow the fuel pump to cycle and prime the system. Turn the key switch **off**.
- b. Turn the key switch to the **start** position, crank and start engine.
- c. If the engine fails to start, repeat steps “a” and “b”. If the engine does not start after two priming intervals, contact your Kohler Engine Service Dealer for further assistance.

NOTE: Do not crank the engine continuously for more than 10 seconds at a time. If the engine does not start, allow a 60 second cool down period between starting attempts. Failure to follow these guidelines can burn out the starter motor.

NOTE: Upon start-up, a metallic ticking may occur. This is caused by hydraulic lifter leakdown during storage. Run the engine for 5 minutes. The noise will normally cease in the first minute. If noise continues, run the engine at mid-throttle for 20 minutes. If noise persists, take the engine to your local Kohler Service outlet.

NOTE: If the engine develops sufficient speed to disengage the starter but does not keep running (a false start), engine rotation must be allowed to come to a complete stop before attempting to restart the engine. If the starter is engaged while the flywheel is rotating, the starter pinion and flywheel ring gear may clash resulting in damage to the starter.

If the starter does not turn the engine over, shut off starter immediately. Do not make further attempts to start the engine until the condition is corrected. Do not jump start using another battery (refer to Battery on page 7). See your Kohler Engine Service Dealer for trouble analysis.

Carbureted Engines Only:

3. **For a Cold Engine** – Gradually return the choke control to the **off** position after the engine starts and warms up.

The engine/equipment may be operated during the warm-up period, but it may be necessary to leave the choke partially on until the engine warms up.

4. **For a Warm Engine** – Return choke to **off** position as soon as engine starts.

Stopping

1. Remove the load by disengaging all PTO driven attachments.
2. **For Carbureted Engines Without A Shutdown Solenoid:** Move the throttle to the **slow** or **low** idle position. Allow the engine to run at idle for 30-60 seconds; then stop the engine.

For Carbureted Engines Equipped With A Shutdown Solenoid: Position the throttle control somewhere between half and full throttle; then stop the engine.

For EFI Engines: Move the throttle to the **slow** or **idle** position; turn key **off** to stop engine.

Battery

A 12 volt battery is normally used. Refer to the operating instructions of the equipment this engine powers for specific battery requirements.

If the battery charge is not sufficient to crank the engine, recharge the battery (see page 15).

Operating

Angle of Operation

This engine will operate continuously at angles up to 20°. Check oil level to assure crankcase oil level is at the “F” mark on the dipstick.

Refer to the operating instructions of the equipment this engine powers. Because of equipment design or application, there may be more stringent restrictions regarding the angle of operation.

NOTE: Do not operate this engine continuously at angles exceeding 20° in any direction. Engine damage could result from insufficient lubrication.

Cooling

NOTE: If debris builds up on the radiator, cooling system, or other external areas, stop the engine immediately and clean. Operating the engine with blocked or dirty cooling system areas can cause extensive damage due to overheating. See Clean Air Intake/Cooling Area, page 14.

High Temperature Sensor

Some engines are equipped with a high temperature sensor mounted in the cooling system. If the safe operating temperature is exceeded, it will either shut off the engine or activate a warning signal, depending on the application.

If the warning light illuminates or engine kills indicating excessive operating temperatures:

1. Make sure all air intake and cooling surfaces are clean and free of debris.
2. After engine has sufficiently cooled, check the coolant level in system to make sure it is not low. See Checking Coolant Level, page 10.



WARNING: Accidental Starts!

Disabling engine. Accidental starting can cause severe injury or death. Before working on the engine or equipment, disable the engine as follows: 1) Disconnect the spark plug lead(s). 2) Disconnect negative (-) battery cable from battery.

Maintenance Schedule

These required maintenance procedures should be performed at the frequency stated in the table. They should also be included as part of any seasonal tune-up.

Frequency	Maintenance Required
Daily or Before Starting Engine	<ul style="list-style-type: none"> • Fill fuel tank. • Check oil level. • Check coolant level. • Check air cleaner for dirty¹, loose, or damaged parts. • Check air intake screen, radiator, and cooling areas, clean as necessary¹.
Every 100 Hours	<ul style="list-style-type: none"> • Clean and check cooling areas².
Annually or Every 200 Hours	<ul style="list-style-type: none"> • Change oil and oil filter (more frequently under severe conditions). • Check spark plug condition and gap. • Replace fuel filter (carbureted engines).
Every 250 Hours	<ul style="list-style-type: none"> • Replace air cleaner element and check inner element¹.
Annually or Every 500 Hours	<ul style="list-style-type: none"> • Replace spark plugs.
Every 2 Years or Every 1000 Hours	<ul style="list-style-type: none"> • Change engine coolant.
Every 1500 Hours	<ul style="list-style-type: none"> • Replace fuel filter¹ (EFI engines),

¹Perform these maintenance procedures more frequently under extremely dusty, dirty conditions.

²Cleanout Kits 25 755 20-S (black) or 25 755 21-S (gold) allow cooling areas to be cleaned without removing shrouds.

3. Check the system for external leaks.
4. If the cause is none of the above or cannot be identified, contact an Authorized Kohler Engine Dealer for appropriate diagnosis and correction.



WARNING: Hot Parts!

Engine components can get extremely hot from operation. To prevent severe burns, do not touch these areas while the engine is running, or immediately after it is turned off. Never operate the engine with heat shields or guards removed.

Engine Speed

NOTE: Do not tamper with the governor setting to increase the maximum engine speed. Overspeed is hazardous and will void the engine warranty. The maximum allowable high idle speed for these engines is 3750 RPM.

Maintenance Instructions

Maintenance, repair, or replacement of the emission control devices and systems, which are being done at the customers expense, may be performed by any non-road engine repair establishment or individual. Warranty repairs must be performed by an authorized Kohler service outlet.

Check Oil Level

The importance of checking and maintaining the proper oil level in the crankcase cannot be overemphasized. Check oil **BEFORE EACH USE** as follows:

1. Make sure the engine is stopped, level, and is cool so the oil has had time to drain into the sump.
2. To keep dirt, debris, etc., out of the engine, clean the area around the dipstick before removing it.
3. Remove the dipstick; wipe oil off. Reinsert the dipstick into the tube and press all the way down. See Figure 6.

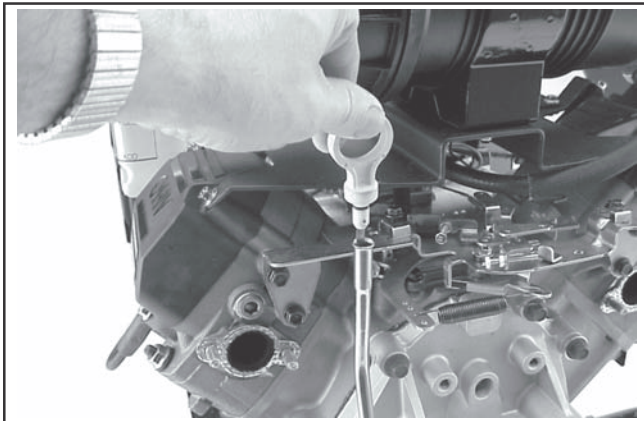

Figure 6. Checking Oil Level.

4. Pull the dipstick out and check the oil level.

The oil level should be up to, but not over, the "F" mark on the dipstick. See Figure 7.

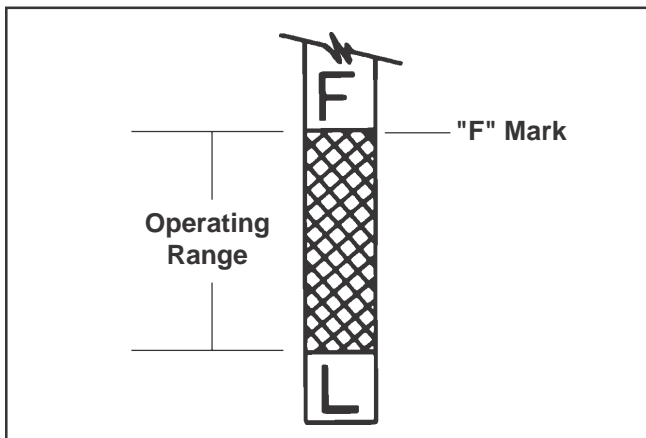

Figure 7. Oil Level Dipstick.

5. If the level is low, add oil of the proper type, up to the "F" mark on the dipstick. (Refer to Oil Type on page 4.) Always check the level with the dipstick before adding more oil.

NOTE: To prevent extensive engine wear or damage, always maintain the proper oil level in the crankcase. Never operate the engine with the oil level below the "L" mark or over the "F" mark on the dipstick.

Oil Sentry™

Some engines are equipped with an optional Oil Sentry™ oil pressure switch monitor. If the oil pressure decreases below an acceptable level, the Oil Sentry™ will either shut off the engine or activate a warning signal, depending on the application.

NOTE: Make sure the oil level is checked **BEFORE EACH USE** and is maintained up to the "F" mark on the dipstick. This includes engines equipped with Oil Sentry™.

Change Oil and Filter

Change the oil and oil filter **every 200 hours or annually**, whichever comes first (more often under severe conditions). Refill with service class SG, SH, SJ or higher oil, as specified in the Viscosity Grades table (Figure 3) on page 4. Always use a genuine Kohler oil filter. Use chart below to determine part number to order.

Oil Filter Part No.	Length
12 050 01-S	2-1/2"
52 050 02-S	3-3/8"

Change the oil while the engine is still warm. The oil will flow more freely and carry away more impurities. Make sure the engine is level when filling, checking, or changing the oil.

Change the oil and oil filter as follows (see Figure 8):

1. To keep dirt, debris, etc., out of the engine, clean the area around the oil fill cap before removing it.
2. Remove one of the oil drain plugs and the oil fill cap. Be sure to allow ample time for complete drainage.
3. Before removing the oil filter, clean the area around the oil filter to keep dirt and debris out of the engine. Remove the old filter and wipe off the filter adapter with a clean cloth.
4. Reinstall the drain plug. Make sure it is tightened to **13.6 N·m (10 ft. lb.)** torque.
5. Place a new replacement filter in a shallow pan with the open end up. Pour new oil, of the proper type, in through the threaded center hole. Stop pouring when the oil reaches the bottom of the threads. Allow a minute or two for the oil to be absorbed by the filter material.

6. Apply a thin film of clean oil to the rubber gasket on the new filter.
7. Install the new oil filter to the filter adapter. Hand tighten the filter (clockwise) until the rubber gasket contacts the adapter, then tighten the filter an additional **3/4 to 1 turn**.
8. Fill the crankcase with new oil of the proper type, to the "F" mark on the dipstick. Refer to Oil Type and Check Oil Level on pages 4 and 9. Always check the level with the dipstick before adding more oil.
9. Reinstall the oil fill cap and tighten securely by turning to the right.

- To prevent engine damage, do not use anti-freeze with stop-leak additive(s) or put other additives in the cooling systems.

Maintenance

This engine is liquid-cooled, circulating a mixture of ethylene glycol and water for dependable operation. A pump is used to circulate the coolant through the system and radiator. A thermostat contained in the system assures automatic temperature control and rapid warm-up. Maintaining the correct coolant level and cleaning any debris accumulation from the inlet screen and radiator surfaces are critical to ensuring long life, proper system performance, and preventing overheating. Check the coolant level in the overflow reservoir, and clean away any debris accumulation daily or before each use. At the same time, inspect the hoses and all connections for signs of leakage.

Servicing

Engine coolant should be changed **every 2 years or every 1000 hours, whichever comes first**. When changing the engine coolant, the system should also be flushed to remove any contaminants left behind during draining. Following are recommended procedures for checking, draining, flushing, and filling the cooling system.

Checking Coolant Level

The coolant level should be checked at the overflow reservoir, located within the formed supports of the fan shroud. See Figure 9.

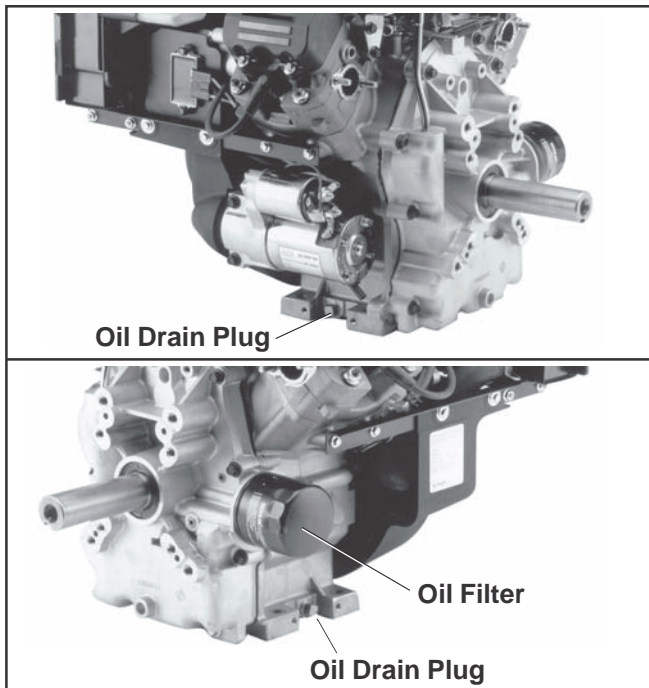

Figure 8. Oil Drain Plugs and Oil Filter.

Cooling System Maintenance and Service Important service notes:

- Do not operate the engine without coolant in the system.
- Do not remove the radiator cap when hot. Engine coolant is hot and under pressure and can cause severe burns.
- To prevent engine overheating and damage, use the recommended anti-freeze mixture in the cooling system.
- To prevent engine damage, do not pour cold water into a hot engine.
- Cooling system capacity is approximately 2 L (2.18 qt.).

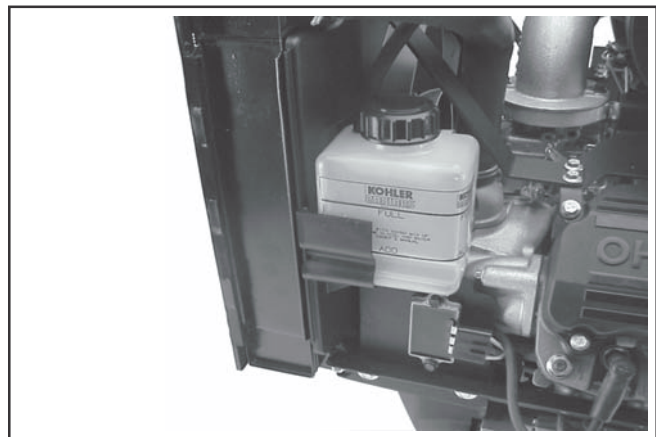

Figure 9. Overflow Reservoir Location.

1. Check the coolant level in the overflow reservoir. Coolant level should be between the "FULL" and "ADD" marks on the reservoir. See Figure 10. **Do not** operate the engine with the coolant level below the "ADD" mark.

Add coolant to the overflow reservoir as required. Use equal parts of ethylene glycol and water only (distilled or deionized water is recommended).

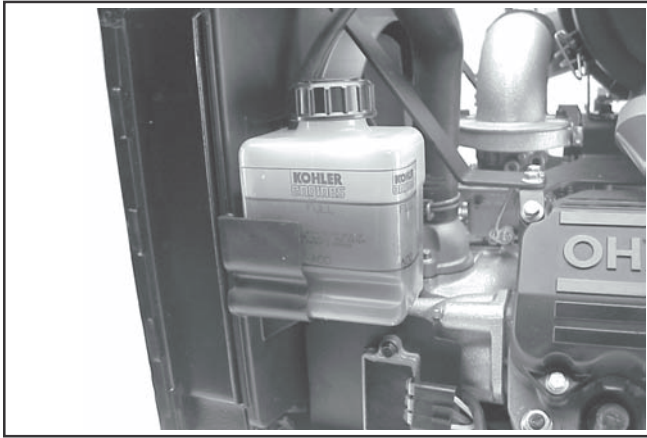

Figure 10. Coolant Levels on Reservoir.

Draining Cooling System

1. Stop the engine and allow it to cool sufficiently.
2. Check if the radiator is cool to the touch. Slowly loosen the radiator cap to the first stop and allow any pressure to bleed off. Then loosen it fully and remove it. Loosen/remove radiator drain plug and allow coolant to drain. See Figure 11.

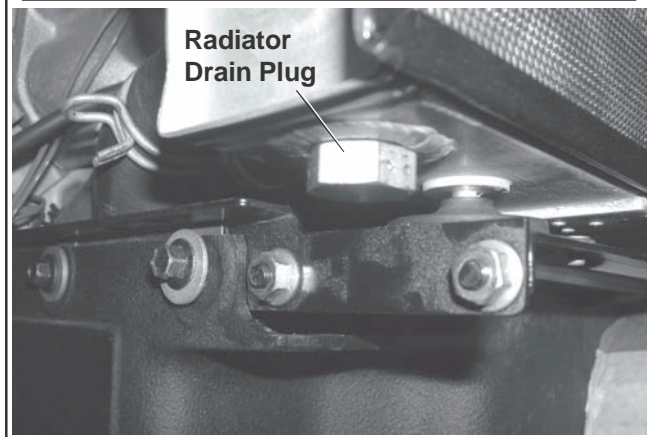
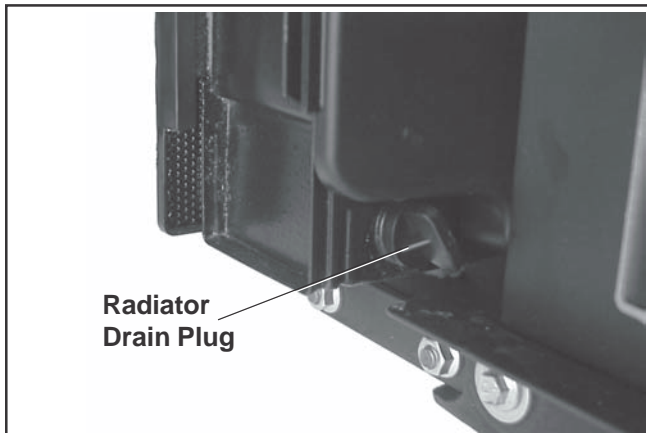

Figure 11. Radiator Drain Plug Location.

3. If equipped, remove the coolant drain plugs located on each side of the engine block. See Figure 12. Drain the coolant into a suitable container. After the coolant has drained completely, apply pipe sealant with Teflon® (Loctite® No. 592 or equivalent), to the threads and reinstall the plugs. Torque the two plugs to 36.7 N·m (325 in. lb.).

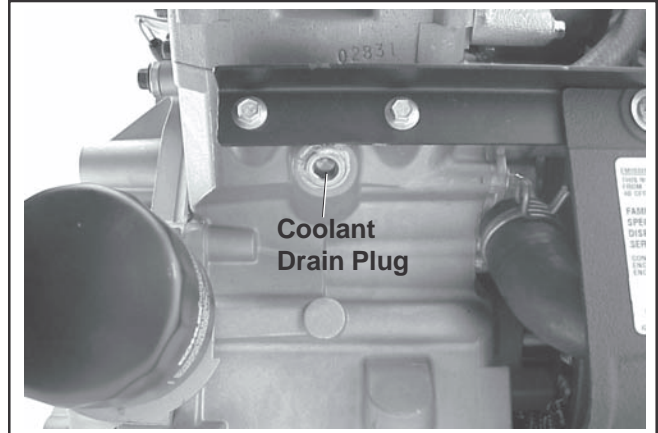

Figure 12. Coolant Drain Plug (Some Models).

4. Remove overflow hose from reservoir. Unhook inboard retainer and slide reservoir out of supports. See Figure 13. Pour out the contents and wash or clean as required. Dispose of all the old coolant properly according to local regulations.



Figure 13. Removing Reservoir.

5. Reinstall the reservoir cap. Do not kink/pinch the hose.
6. Flush the cooling system (see Flushing Cooling System).

Flushing Cooling System

With system properly drained:

1. Fill the cooling system with clean water and a cooling system cleaner recommended for aluminum engines. Follow the directions on the container.

2. Reinstall and tighten the radiator cap.
3. Start and run the engine for five minutes, or until it reaches operating temperature. Stop the engine and allow it to cool.
4. Drain the cooling system (Refer to Draining Cooling Systems).
5. Fill the cooling system (see Filling Cooling System).

Filling Cooling System

1. Check the condition of cooling system hoses, clamps, and associated components. Replace as required.
2. Mix equal parts of ethylene glycol anti-freeze and distilled or deionized water (see Coolant Recommendations on page 5). For extremely cold temperature applications or protection outside the limits listed in the Coolant Recommendations Section, refer to the anti-freeze manufacturers instructions on the container, but do not exceed 70% anti-freeze.
3. Fill the radiator with the coolant mixture. Allow coolant to drain into the lower areas. Fill the overflow reservoir to a level between the "FULL" and "ADD" marks. See Figure 9. Reinstall the radiator and reservoir caps.
4. Start and run the engine for five minutes. Stop the engine and allow to cool.
5. Recheck the coolant level in the reservoir. Coolant level should be between the "FULL" and "ADD" marks. Add coolant to reservoir if required. See Figure 9.

Air Cleaner Element and Inner Element Service

This engine is equipped with a heavy-duty high density paper air cleaner element surrounding a canister style inner element. Cleaning is not recommended, each element should be replaced when dirty. See Figure 14.

The air cleaner system should be inspected **daily or before starting the engine**, for a buildup of dirt and debris, or for any damaged or loose components. Keep the system clean and properly secured. Replace any damaged air cleaner components. **Do not** operate the engine without the complete air cleaner system installed and properly secured.

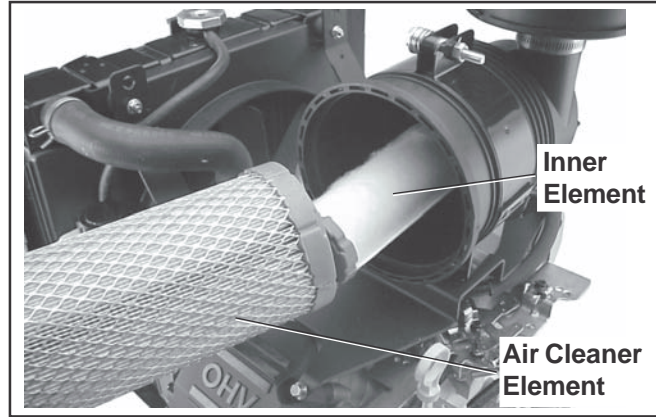

Figure 14. Air Cleaner Element and Inner Element.

NOTE: Operating the engine with loose, damaged, or missing air intake components can allow unfiltered air into the engine, causing premature wear and failure.

To Service

Every **250 hours** of operation (more often under extremely dusty or dirty conditions), replace the paper element and check the inner element. Follow these steps.

1. Unhook the two retaining clips and remove the end cap from the air cleaner housing. See Figure 15.

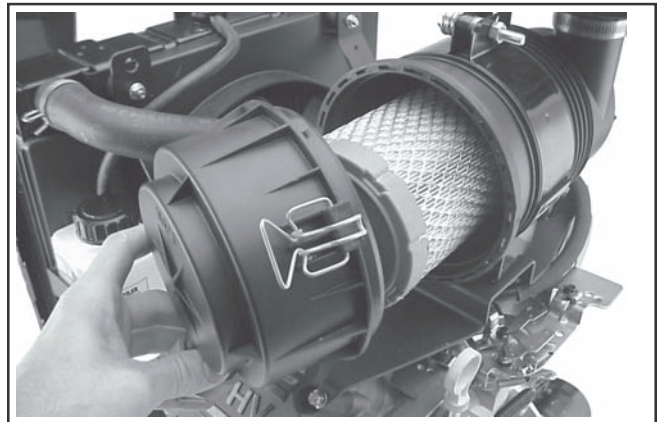

Figure 15. Removing End Cap.

2. Pull the air cleaner element out of the housing. See Figure 16.

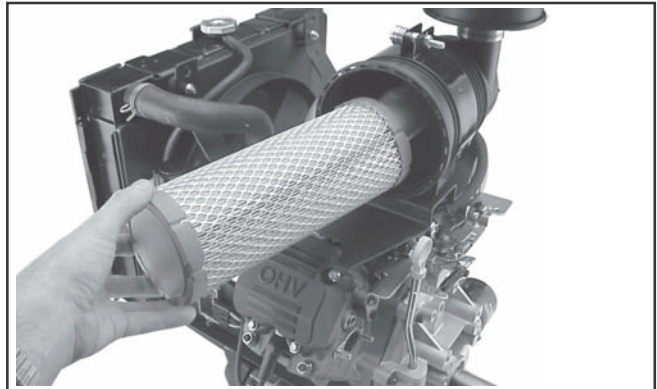

Figure 16. Removing Air Cleaner Element.

3. After the main element is removed, check the condition of the inner element. It should be replaced whenever it appears dirty, typically every other time the main element is replaced. Clean the area around the base of the inner element before removing it, so dirt does not get into the engine. See Figure 17.

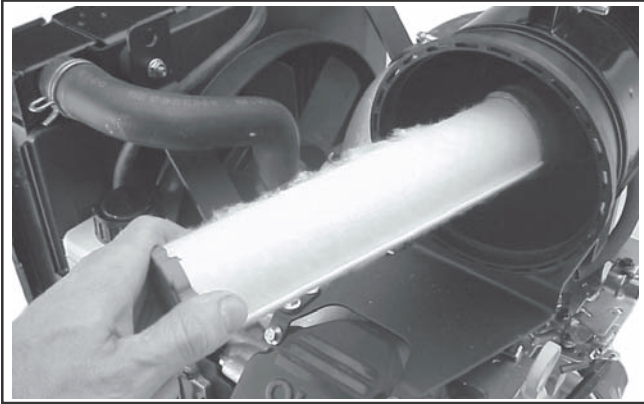

Figure 17. Removing Inner Element.

4. **Do not** wash the paper element and inner element or use pressurized air, this will damaged the elements. Replace dirty, bent, or damaged elements with new genuine Kohler elements as required. Handle new elements carefully; do not use if the sealing surfaces are bent or damaged.
5. Check all parts for wear, cracks, or damage. Replace any damaged components.
6. Install the new inner element, Kohler Part No. 25 083 04-S followed by the outer element, Kohler Part No. 25 083 01-S. Slide each fully into place in the air cleaner housing.
7. Reinstall the end cap so the dust ejector valve is down and secure with the two retaining clips. See Figure 18.

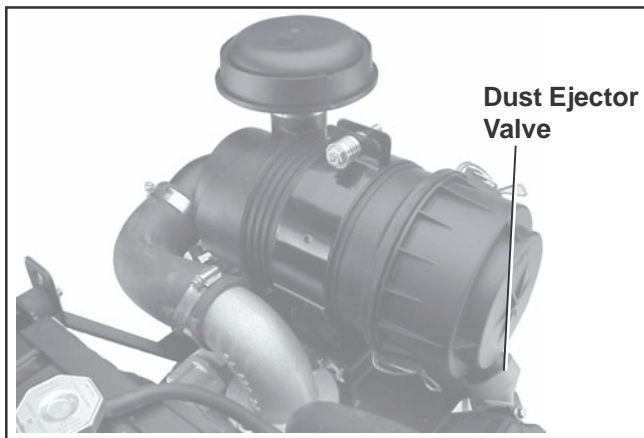

Figure 18. Air Cleaner Assembly.

Air Intake System and Air Cleaner Components

Air Cleaner Housing/End Cap Assembly

Make sure air cleaner housing including the dust ejector valve and the end cap is in good condition and not cracked. The two retainer clips should positively lock when cap is installed.

Air Cleaner Hose

Inspect the air cleaner hose to make sure it is not cracked, split or damaged. Check that the air cleaner hose is securely clamped to both the air cleaner outlet and the inlet elbow on the carburetor.

Air Cleaner Mounting Base

Make sure the base is securely fastened to the upper valve cover screw locations and the screws securing the clamp bracket for the air cleaner housing are properly installed and tight.

Breather Tube

Make sure the tube is in good condition and is properly secured to both the breather cover and elbow adapter.

Cooling Fan Assembly, Belt, and Drive Pulleys

The cooling fan assembly, used to draw the air in and across the radiator, is attached to a hub and pulley assembly with sealed ball bearings. It is belt driven by a lower split pulley attached to the flywheel and requires very little service or maintenance. **DO NOT operate the engine without the fan and cooling system functioning properly, or engine damage will occur.** See Figure 19.

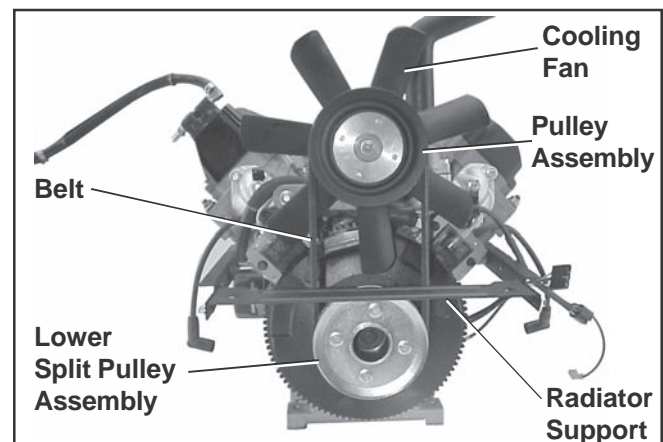

Figure 19. Cooling System Belt Drive (Cover and Radiator Removed For Clarity).

1. Inspect the fan for any cracks, damaged/missing fan blades, and secure mounting.
2. The bearings, within the bearing carrier in the hub of the pulley, should rotate smoothly, without roughness, binding, or play/wobble.

3. The v-groove of each pulley (upper and lower) should not be bent, nicked, or damaged. Pulley mounting areas and lower pulley shims should be free of any cracks or elongation. See Figure 20.

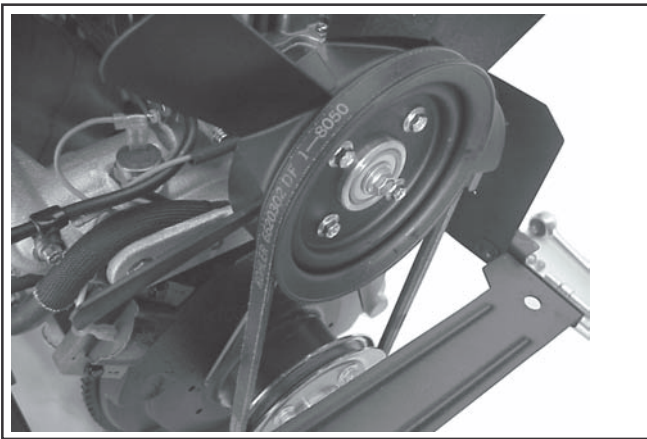

Figure 20. Pulley and Drive Belt.

4. The drive belt is designed and constructed for this application. **Do not use a substitute belt.** Check the overall condition of the belt. If belt is cracked, damaged, or adequate tension does not exist, have necessary servicing performed by an authorized Kohler Engine Service Dealer.

Clean Air Intake/Cooling Areas

To ensure proper air circulation and cooling, make sure the serviceable screen, radiator cooling fins, fan assembly and external surfaces of the engine are kept clean **at all times**.

Every **100 hours** of operation (more often under extremely dusty, dirty conditions), thoroughly clean the radiator cooling fins, fan assembly, intake system and external surfaces of the engine. Make sure all parts are reinstalled before starting the engine.

Clean the cooling fins of the screen and radiator with a soft brush or blow out, using clean, compressed air. See Figure 21. **Do not** use a high pressure washer, to avoid damaging the cooling fins.

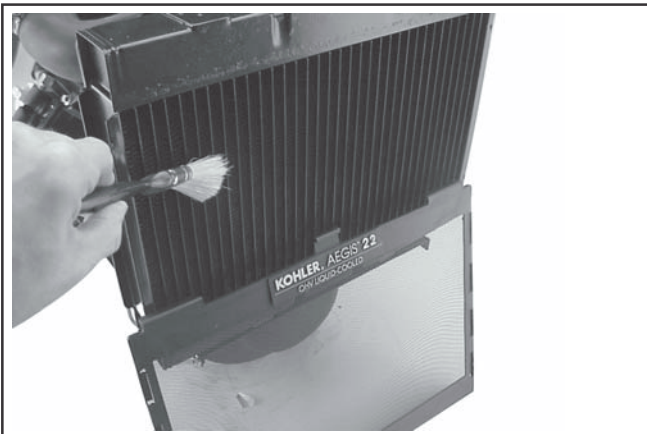

Figure 21. Clean Radiator Cooling Fins and Screen.

NOTE: Operating the engine with a restricted air intake screen or radiator, damaged/broken fan assembly, or missing fan shroud will cause engine damage due to overheating.

Ignition System

Carbureted Engines - Use an electronic Capacitive Discharge (CD) ignition system. Other than periodically checking/replacing the spark plugs, no maintenance, timing, or adjustments are necessary or possible with this system.

EFI Engines - Incorporate a computer-controlled battery ignition system with individual coils. Other than periodically checking/replacing the spark plugs, no maintenance, timing, or adjustments are necessary or possible with this system.

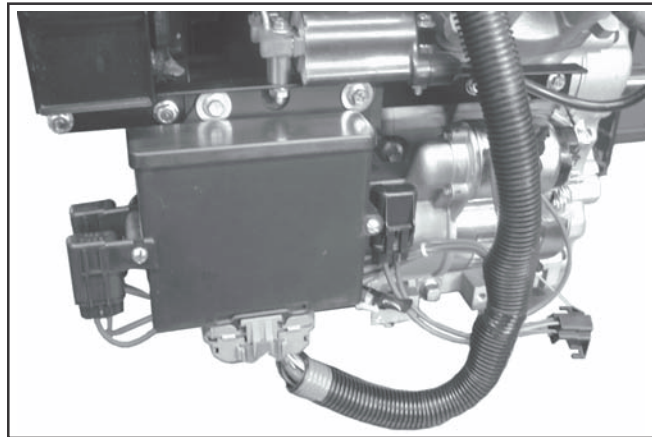

Figure 22.

In the event starting problems should occur, which are not corrected by replacing the spark plugs, see your Kohler Engine Service Dealer for trouble analysis.

Check Spark Plugs

Annually or every **200 hours** of operation (whichever comes first), remove the spark plugs, check condition, and reset the gap or replace with new plugs as necessary. Every **500 hours** of operation replace the spark plugs. The standard spark plug is a Champion® RC14YC (Kohler Part No. **66 132 01-S**). Equivalent alternate brand plugs can also be used.

1. Before removing the spark plug, clean the area around the base of the plug to keep dirt and debris out of the engine.
2. Remove the plug and check its condition. Replace the plug if worn or reuse is questionable.

NOTE: Do not clean the spark plug in a machine using abrasive grit. Some grit could remain in the spark plug and enter the engine, causing extensive wear and damage.

3. Check the gap using a wire feeler gauge. Adjust the gap to **0.76 mm (0.030 in.)** by carefully bending the ground electrode. See Figure 23.
4. Reinstall the spark plug into the cylinder head. Torque the spark plug to **24.4-29.8 N·m (18-22 ft. lb.)**.

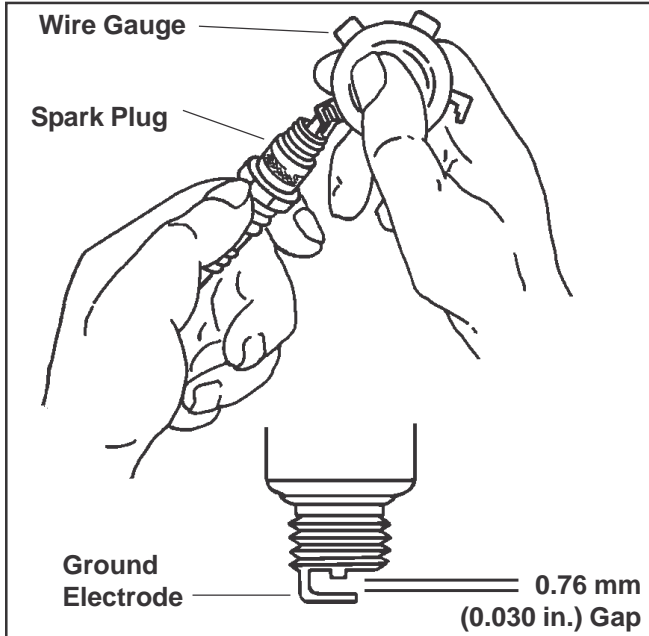

Figure 23. Servicing Spark Plug.

Battery Charging



WARNING: Explosive Gas!

Batteries produce explosive hydrogen gas while being charged. To prevent a fire or explosion, charge batteries only in well ventilated areas. Keep sparks, open flames, and other sources of ignition away from the battery at all times. Keep batteries out of the reach of children. Remove all jewelry when servicing batteries.

Before disconnecting the negative (-) ground cable, make sure all switches are OFF. If ON, a spark will occur at the ground cable terminal which could cause an explosion if hydrogen gas or gasoline vapors are present.

NOTE: Do not apply 12 volt DC to kill terminal of ignition module.

Fuel Filter

Carbureted Engines: Most engines are equipped with an in-line fuel filter. Periodically inspect the filter and replace every **200 operating hours**. Use a genuine Kohler filter, Part No. 24 050 10-S.

EFI Engines: A special, high volume, high pressure filter with greater filtration capabilities and internal surface area is used. See Figure 24.

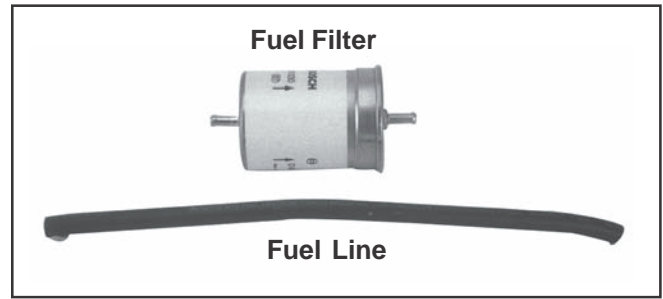

Figure 24. EFI Fuel Filter and Line.

Replacement is recommended **every 1500 hours**, or more frequently under extremely dusty or dirty conditions. When replacement is necessary, always use genuine Kohler parts.

Fuel Line

Carbureted Engines: In compliance with CARB Tier III Emission Regulations, carbureted engines with a Family identification number beginning with "6" or greater (see Figure 25), must use Low Permeation SAE 30 R7 rated fuel line; certified to meet CARB requirements. Standard fuel line may not be used. Order replacement hose by part number through a Kohler Engine Service Dealer.

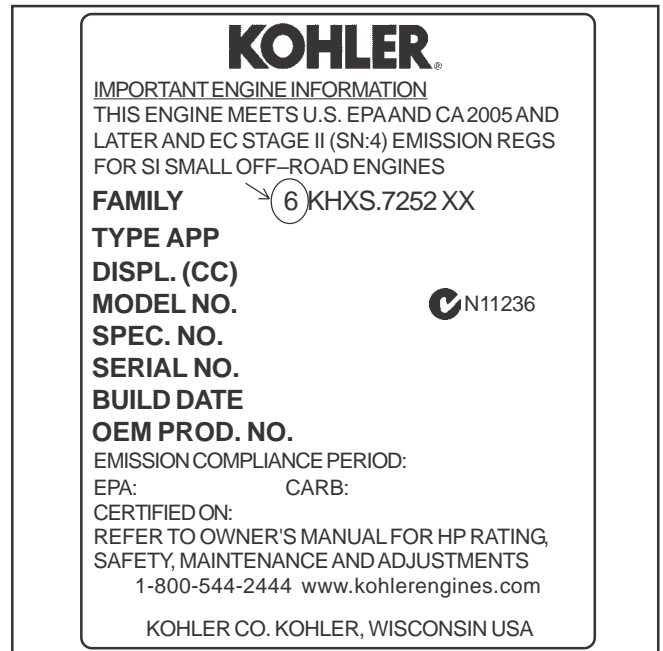

Figure 25. Family Number Location.

EFI Engines: A special fuel line, capable of withstanding the high pressure of the EFI fuel system, is used (must meet SAE R9 specifications). See Figure 24. If fuel line must be replaced, see your Kohler Engine Service Dealer.

Carburetor Troubleshooting and Adjustments

In compliance with the government emission standards, the carburetor is calibrated to deliver the correct fuel-to-air mixture to the engine under all operating conditions. The carburetor cannot be adjusted, except for low idle speed (RPM). Carburetor servicing is to be performed by an authorized Kohler Engine Service Dealer only. See Figure 26.

NOTE: To ensure correct engine operating at altitudes above 1525 meters (5000ft.), it may be necessary to have an authorized Kohler dealer install a special high-altitude jet kit in the carburetor. If a high-altitude kit has been installed, the engine must be reconverted to the original jet size, before it is operated at lower altitudes, or overheating and engine damage can result.

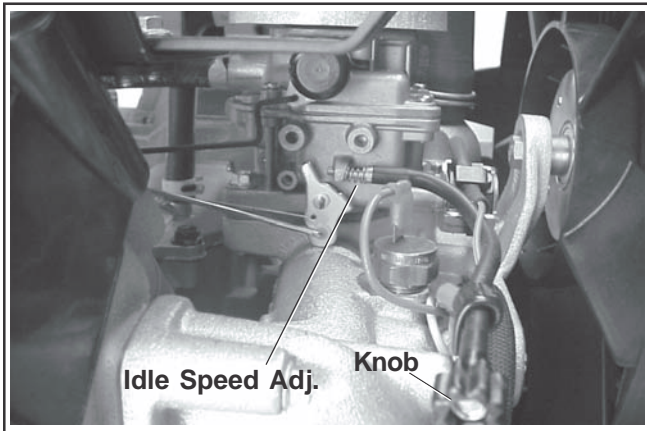

Figure 26. Carburetor and Idle Speed Adjustment.

Troubleshooting

If engine troubles are experienced that appear to be fuel system related, check the following areas before adjusting the carburetor.

- Make sure the fuel tank is filled with clean, fresh gasoline.
- Make sure the fuel tank cap vent is not blocked and that it is operating properly.
- If the fuel tank is equipped with a shut-off valve, make sure it is open.
- If the engine is equipped with an in-line fuel filter, make sure it is clean. Replace the filter if it is dirty or restricted.
- Make sure fuel is reaching the carburetor. This includes checking the fuel lines and fuel pump for restrictions or faulty components, replace as necessary.
- Make sure cooling system is filled to the proper level.

- Make sure the air cleaner element and precleaner are clean and properly secured.
- Make sure the air intake screen, blower housing, and cooling surfaces of radiator are clean and free of dirt and debris.

If, after checking the items listed above, the engine is hard to start, runs roughly, or stalls at low idle speed, it may be necessary to adjust or service the carburetor.

Adjust Carburetor

Start the engine and run at half throttle for 5 to 10 minutes to warm up. The engine must be warm before making final settings.

Low idle speed (RPM) setting:

1. Place the throttle control into the **idle** or **slow** position. Set the low idle speed to **1200 RPM*** (± 75 RPM) by turning the low idle speed adjusting screw (cable w/knob on some models) **in or out**. Check the speed using a tachometer.

***NOTE:** The actual low idle speed depends on the application – refer to equipment manufacturers recommendations. The standard low idle speed is 1200 RPM.

2. If proper operation is not restored after adjusting the low idle speed, carburetor servicing by an authorized Kohler Engine Service Dealer may be required.

Electronic Fuel Injection (EFI) System

The EFI system is a complete, electronically-controlled fuel management system, designed to deliver a precisely controlled fuel flow under all operating conditions. The electronic control unit (ECU), the “brain” of the system, automatically adjusts fuel delivery and ignition timing based upon load, speed, operating temperature, and exhaust emission levels. The low idle speed is the only manual adjustment possible.

The ECU continuously monitors operation of the EFI system. If it detects a problem or fault within the system, it will illuminate the malfunction indicator light (MIL), which is mounted in view of the operator. This is a signal that normal, programmed operation has been affected, and service by an authorized Kohler Engine Dealer is required.

NOTE: The EFI system requires a rather complex wiring harness to carry the electrical signals between the sensors and the ECU. **Do not** spray water at the wiring harness or any of the electrical components, especially the ECU, as it could cause malfunction, damage, or failure.

Troubleshooting

If the MIL comes on, or the engine becomes hard to start, runs roughly, or stalls at low idle speed, initial checks should be made in the following areas:

- Make sure the fuel tank is filled with clean, fresh gasoline, and shut-off valve (if so equipped) is opened completely.
- Make sure fuel tank vent cap is not blocked and it is operating properly.
- Make sure the air cleaner element and precleaner are clean and all components are properly secured. Clean or replace as necessary.
- Make sure the proper fuel filter is being used, and it is clean and unobstructed. Replace filter **only** with genuine Kohler parts.
- Make sure all connections to sensors, ECU, and fuel injectors are properly secured.
- Make sure a good 12 volt battery is being used and is fully charged.

If these checks do not correct the problem, or the MIL remains on, further diagnosis and servicing by an authorized Kohler Engine Dealer is necessary.

Adjustment – EFI Throttle Body

Low Idle Speed (RPM) is the only adjustment that can be made. All other fuel calibrations are permanently preset and controlled by the ECU. The standard low idle speed is **1500 RPM*** (+ 75 RPM).

Troubleshooting

When troubles occur, be sure to check the simple causes which, at first, may seem too obvious to be considered. For example, a starting problem could be caused by an empty fuel tank. Some common causes of engine troubles are listed in the following table.

Do not attempt to service or replace major engine components, or any items that require special timing or adjustment procedures. Have your Kohler Engine Service Dealer do this work.

Possible Cause Problem	No Fuel	Improper Fuel	Dirt In Fuel Line/System	Dirty Grass Screen	Incorrect Oil Level	Engine Overloaded	Dirty Air Cleaner	Faulty Spark Plug
Will Not Start	•	•	•		•	•	•	•
Hard Starting	•	•	•			•	•	•
Stops Suddenly	•		•	•	•	•	•	•
Lacks Power		•	•	•	•	•	•	•
Operates Erratically		•	•	•		•	•	•
Knocks or Pings		•	•	•		•		•
Skips or Misfires		•	•	•			•	•
Backfires		•	•			•	•	•
Overheats		•	•	•	•	•	•	
High Fuel Consumption						•	•	•

*NOTE: The actual low idle speed depends on the application -- refer to equipment manufacturer's recommendations.

When an EFI engine is started cold, the ECU will be using internal programming for cold running, and the idle speed may vary from the manual setting. Do not attempt to perform any readjustment during this "warm-up" period.

If adjustment is to be made, the engine must be at operating temperature, air cleaner in place, and check engine light must be off (no fault codes present).

1. Start the engine and run at half throttle for 5 to 10 minutes to warm up.
2. Place the throttle control into the **idle** or **slow** position.
3. Turn the low idle speed adjusting screw in or out and check RPM with a tachometer. See Figure 27.

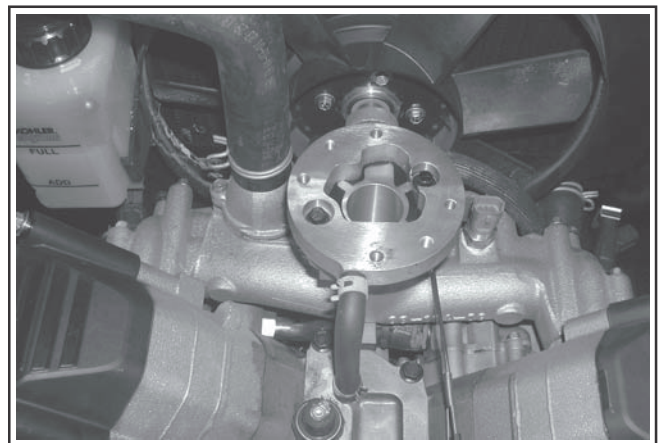

Figure 27. EFI Throttle Body Manifold.

Storage

If the engine will be out of service for two months or more, use the following storage procedure:

1. Clean the exterior surfaces of the radiator and engine. On EFI engines, avoid spraying water at the wiring harness or any of the electrical components.
2. Change the oil and filter while the engine is still warm from operation. See Change Oil and Filter on page 9.
3. The coolant (anti-freeze) mixture should be in good condition and tested to guard against freezing in cold temperatures. The recommended 50/50 mixture will normally provide protection down to temperatures of -37°C (-34°F). If storage temperatures will fall below this, the cooling system should be drained completely. A note should then be attached to the equipment and/or engine as a reminder to refill the cooling system before starting.
4. The fuel system must be completely emptied, or the gasoline must be treated with a stabilizer to prevent deterioration. If you choose to use a stabilizer, follow the manufacturers recommendations, and add the correct amount for the capacity of the fuel system. Fill the fuel tank with clean, fresh gasoline. Run the engine for 2-3 minutes to get stabilized fuel into the carburetor. Close fuel shut-off valve when unit is being stored or transported.

To empty the system, run the engine until the tank and system are empty.

5. Remove the spark plugs. Add one tablespoon of engine oil into each spark plug hole. Install plugs, but do not connect the plug leads. Crank the engine two or three revolutions.
6. On units with EFI engines, disconnect the negative (-) battery cable or use a "battery minder" trickle charger while the unit is in storage.
7. Store the engine in a clean, dry place.

Parts Ordering

The engine Specification, Model, and Serial Numbers are required when ordering replacement parts from your Kohler Engine Service Dealer. These numbers are found on the identification plate which is affixed to the engine shrouding. Include letter suffixes if there are any. See Engine Identification Numbers on page 5.

Always insist on genuine Kohler parts. All genuine Kohler parts meet strict standards for fit, reliability, and performance.

Major Repair

Major repair information is available in Kohler Engine Service Manuals. This type of repair generally requires the services of a trained mechanic and the use of special tools and equipment. Kohler Engine Service Dealers have the facilities, training, and genuine Kohler replacement parts necessary to perform this service.

For the nearest Sales & Service location:

- visit our website www.kohlerengines.com
- call 1-800-544-2444 (U.S. & Canada)
- look in the yellow pages under Engines-Gasoline

Specifications

Model:	LH630/LH640	LH685/LH690	LH755	LH775
Bore:	3.03 (77)	3.15 (80)	3.3 (83)	3.3 (83)
Stroke:	2.64 (67)	2.64 (67)	2.7 (69)	2.7 (69)
Displacement:	38.1 (624)	41.1 (674)	45.6 (748)	45.6 (748)
Power (Max. @3600 RPM):	22* (16.4)/24* (17.9)	25* (18.6)/26* (19.4)	28* (20.9)	31* (23.1)*
Compression Ratio:	8.5:1	8.5:1	8.7:1	8.7:1
Dry Weight:	114 (51.7)	114 (51.7)	114 (51.7)	114 (51.7)
Coolant/Anti-Freeze:	U.S. qts. (L) ----- Equal Parts of Water and Ethylene Glycol 2.18 (2.0) -----			
Lubrication:	----- Full Pressure w/full Flow Filter -----			
Oil Capacity (w/filter) - approximate, determined by oil filter used:	----- 1.6-1.8 L (1.7-1.9 U.S. qt.) -----			

Exhaust Emission Control System for models LH630, LH640, LH685, LH690, and LH755 is EM.

Exhaust Emission Control System for models LH775 is EM, O2S, ECM, MFI.

*Horsepower ratings exceed Society of Automotive Engineers Small Engine Test Code J1940. Actual engine horsepower is lower and affected by, but not limited to, accessories (air cleaner, exhaust, charging, cooling, fuel pump, etc.), application, engine speed and ambient operating conditions (temperature, humidity, and altitude). Kohler reserves the right to change product specifications, designs and equipment without notice and without incurring obligation.

LIMITED 3 YEAR KOHLER AEGIS® ENGINE WARRANTY

Kohler Co. warrants to the original retail consumer that each new KOHLER AEGIS® engine sold by Kohler Co. will be free from manufacturing defects in materials or workmanship in normal residential service for a period of three (3) years from date of purchase, provided it is operated and maintained in accordance with Kohler Co.'s instructions and manuals.

Our obligation under this warranty is expressly limited, at our option, to the replacement or repair at Kohler Co., Kohler, Wisconsin 53044, or at a service facility designated by us of such parts as inspection shall disclose to have been defective.

EXCLUSIONS:

Mufflers on engines used commercially (non-residential) are warranted for one (1) year from date of purchase, except catalytic mufflers, which are warranted for two (2) years.

This warranty does not apply to defects caused by casualty or unreasonable use, including faulty repairs by others and failure to provide reasonable and necessary maintenance.

The following items are not covered by this warranty:

Engine accessories such as fuel tanks, clutches, transmissions, power-drive assemblies, and batteries, unless supplied or installed by Kohler Co. These are subject to the warranties, if any, of their manufacturers.

KOHLER CO. AND/OR THE SELLER SHALL NOT BE LIABLE FOR SPECIAL, INDIRECT, INCIDENTAL, OR CONSEQUENTIAL DAMAGES OF ANY KIND, including but not limited to labor costs or transportation charges in connection with the repair or replacement of defective parts.

IMPLIED OR STATUTORY WARRANTIES, INCLUDING WARRANTIES OF MERCHANTABILITY OR FITNESS FOR A PARTICULAR PURPOSE, ARE EXPRESSLY LIMITED TO THE DURATION OF THIS WRITTEN WARRANTY. We make no other express warranty, nor is any one authorized to make any on our behalf.

Some states do not allow limitations on how long an implied warranty lasts, or the exclusion or limitation of incidental or consequential damages, so the above limitation or exclusion may not apply to you.

This warranty gives you specific legal rights, and you may also have other rights, which vary from state to state.

TO OBTAIN WARRANTY SERVICE:

Purchaser must bring the engine to an authorized Kohler service facility. To locate the nearest facility, visit our website, www.kohlerengines.com, and click on SALES AND SERVICE to use the locator function, consult your Yellow Pages or telephone 1-800-544-2444. ENGINE DIVISION, KOHLER CO., KOHLER, WISCONSIN 53044

KOHLER CO. FEDERAL AND CALIFORNIA EMISSION CONTROL SYSTEMS LIMITED WARRANTY SMALL OFF-ROAD AND CLASS 1 LSI ENGINES

The U.S. Environmental Protection Agency (EPA), the California Air Resources Board (CARB), and Kohler Co. are pleased to explain the Federal and California Emission Control Systems Warranty on your off-road equipment engine. In California beginning in 2006, "emissions" means both exhaust and evaporative emissions. For California, small off-road engines produced in 2006 and later, and Class 1 LSI (Large Spark Ignited engines at or below 1.0 liter) produced in 2002 and later, must be designed, built and equipped to meet the state's stringent anti-smog standards. In other states, 1997 and later model year engines must be designed, built and equipped, to meet the U.S. EPA regulations for small non-road engines. The engine must be free from defects in materials and workmanship, which cause it to fail to conform with U.S. EPA standards for the first two years of engine use from the date of sale to the ultimate purchaser. Kohler Co. must warrant the emission control system on the engine for the period of time listed above, provided there has been no abuse, neglect or improper maintenance.

The emission control system may include parts such as the carburetor or fuel injection system, the ignition system, and catalytic converter. Also included are the hoses, belts and connectors and other emission-related assemblies.

Where a warrantable condition exists, Kohler Co. will repair the engine at no cost, including diagnosis (if the diagnostic work is performed at an authorized dealer), parts and labor.

MANUFACTURER'S WARRANTY COVERAGE

Small off-road engines produced in 2006 or later, and Class 1 LSI engines produced in 2002 and later, are warranted for two years in California. In other states, 1997 and later model year engines are warranted for two years. If any emission related part on the engine is defective, the part will be repaired or replaced by Kohler Co. free of charge.

OWNER'S WARRANTY RESPONSIBILITIES

- (a) The engine owner is responsible for the performance of the required maintenance listed in the owner's manual. Kohler Co. recommends that you retain all receipts covering maintenance on the engine, but Kohler Co. cannot deny warranty solely for the lack of receipts or for your failure to assure that all scheduled maintenance was performed.
- (b) Be aware, however, that Kohler Co. may deny warranty coverage if the engine or a part has failed due to abuse, neglect, improper maintenance or unapproved modifications.

Continued on next page.

- (c) For warranty repairs, the engine must be presented to a Kohler Co. service center as soon as a problem exists. Call 1-800-544-2444 or access our website at: www.kohlerengines.com, for the names of the nearest service centers. The warranty repairs should be completed in a reasonable amount of time, not to exceed 30 days.

If you have any questions regarding warranty rights and responsibilities, you should contact Kohler Co. at 1-920-457-4441 and ask for an Engine Service representative.

COVERAGE

Kohler Co. warrants to the ultimate purchaser and each subsequent purchaser that the engine will be designed, built and equipped, at the time of sale, to meet all applicable regulations. Kohler Co. also warrants to the initial purchaser and each subsequent purchaser, that the engine is free from defects in materials and workmanship which cause the engine to fail to conform with applicable regulations for a period of two years.

Small off-road engines produced in 2006 or later, and Class 1 LSI engines produced in 2002 and later, are warranted for two years in California. For 1997 and later model years, EPA requires manufacturers to warrant engines for two years in all other states. These warranty periods will begin on the date the engine is purchased by the initial purchaser. If any emission related part on the engine is defective, Kohler Co. will replace the part at no cost to the owner. Kohler Co. is liable for damages to other engine components caused by the failure of a warranted part still under warranty.

Kohler Co. shall remedy warranty defects at any authorized Kohler Co. engine dealer or warranty station. Warranty repair work done at an authorized dealer or warranty station shall be free of charge to the owner if such work determines that a warranted part is defective.

Listed below are the parts covered by the Federal and California Emission Control Systems Warranty. Some parts listed below may require scheduled maintenance and are warranted up to the first scheduled replacement point for that part. The warranted parts include the following if they were present in the engine purchased:

- Oxygen sensor (if equipped)
- Intake manifold (if equipped)
- Exhaust manifold (if equipped)
- Catalytic muffler (if equipped)
- Thermal reactor muffler (if equipped)
- Fuel lines, fuel line fittings and clamps (if equipped)
- Spark advance module (if equipped)
- Crankcase breather
- Air Injection System (if equipped)
 - Air pump or pulse valve assembly (if equipped)
 - Control/distribution valve (if equipped)
 - Distribution manifold (if equipped)
 - Air hoses (if equipped)
 - Vacuum lines (if equipped)
- Ignition module(s) with high tension lead
- Gaseous fuel regulator (if equipped)
- Electronic control unit (if equipped)
- Carburetor or fuel injection system
- Fuel metering valve (if equipped)
- Air filter, fuel filter, and spark plugs (only to first scheduled replacement point)
- Evaporative System (if equipped)
 - Canister (if equipped)
 - Canister filter (if equipped)
 - Vapor hose (if equipped)
 - Orifice connector (if equipped)
 - Fuel tank (if equipped)
 - Fuel cap (if equipped)
 - Primer bulb canister (if equipped)

LIMITATIONS

This Emission Control Systems Warranty shall not cover any of the following:

- (a) repair or replacement required because of misuse or neglect, improper maintenance, repairs improperly performed or replacements not conforming to Kohler Co. specifications that adversely affect performance and/or durability and alterations or modifications not recommended or approved in writing by Kohler Co.,
- (b) replacement of parts and other services and adjustments necessary for required maintenance at and after the first scheduled replacement point,
- (c) consequential damages such as loss of time, inconvenience, loss of use of the engine or equipment, etc.,
- (d) diagnosis and inspection fees that do not result in eligible warranty service being performed, and
- (e) any add-on or modified part, or malfunction of authorized parts due to the use of add-on or modified parts.

MAINTENANCE AND REPAIR REQUIREMENTS

The owner is responsible for the proper use and maintenance of the engine. Kohler Co. recommends that all receipts and records covering the performance of regular maintenance be retained in case questions arise. If the engine is resold during the warranty period, the maintenance records should be transferred to each subsequent owner. Kohler Co. reserves the right to deny warranty coverage if the engine has not been properly maintained; however, Kohler Co. may not deny warranty repairs solely because of the lack of repair maintenance or failure to keep maintenance records.

Normal maintenance, replacement or repair of emission control devices and systems may be performed by any repair establishment or individual; however, **warranty repairs must be performed by a Kohler authorized service center**. Any replacement part or service that is equivalent in performance and durability may be used in non-warranty maintenance or repairs, and shall not reduce the warranty obligations of the engine manufacturer.

KOHLER[®] ENGINES

FOR SALES AND SERVICE INFORMATION
IN U.S. AND CANADA, CALL **1-800-544-2444**

KohlerEngines.com

ENGINE DIVISION, KOHLER CO., KOHLER, WISCONSIN 53044

FORM NO.:	66 590 02
ISSUED:	12/04
REVISED:	1/08

LITHO IN U.S.A.



1P66 590 02



6 50531 25243 2